



# USER'S MANUAL



WIRELESS TOUCH  
CONTROL UNIT

# BU-TS user manual

We want to thank you for your purchase of the BU-TS control unit, which is an element of wireless RF Control system.

## BU-TS allows:

- you to control many devices trough touch screen
  - heating control
  - dimming lights
  - switching of electrical appliances and equipment
  - blinds
  - a combination of detectors
  - function timers
  - Group control of electrical equipment
- everything with clear visualization
- wireless communication without the need for cabling



<i>ETI device name</i>	<i>ELKO device name</i>
<i>BU-SU</i>	<i>RFSA-11B</i>
<i>BU-DU</i>	<i>RFDA-11B</i>
<i>BU-SU Multi</i>	<i>RFSA-61B</i>
<i>BU-DU Multi</i>	<i>RFDA-71B</i>
<i>BU-WS2</i>	<i>RFWB-20</i>
<i>BU-WS4</i>	<i>RFWB-40</i>
<i>BU-KC4</i>	<i>RFK-40</i>
<i>BU-UT2</i>	<i>RFIM-20B</i>
<i>BU-SHU</i>	<i>RFJA-12B/230</i>
<i>BU-TCU</i>	<i>RFSTI-11B</i>
<i>BU-DAU</i>	<i>RFDAC-71B</i>
<i>BU-DEU</i>	<i>RFDEL-71B</i>
<i>BU-UT4</i>	<i>RFIM-40B</i>
<i>BU-TSD</i>	<i>RFTB-AWH-BWH</i>
<i>BU-TSW</i>	<i>RFTW-AWH-BWH-CWH</i>
<i>BU Pilot with LCD - black</i>	<i>RF Pilot / gray</i>
<i>BU Pilot with LCD - white</i>	<i>RF Pilot / white</i>
<i>BU keychain - black</i>	<i>RF KEY (black)</i>
<i>BU keychain - white</i>	<i>RF KEY (white)</i>

## Contents:

■ <b>Before you start</b> .....	3	■ <b>Settings</b>		■ <b>Control</b>	23
■ <b>Overview of wireless devices</b> ...	4	- <b>Default setting</b> .....	12	- <b>Temperature regulation</b> .....	23
■ <b>Characteristics of BU-TS</b> .....	6	- <b>Menu(creating and naming)</b> ...	13	- <b>Switching</b> .....	26
■ <b>Technical specifications</b> .....	7	- <b>Programming</b> .....	15	- <b>Dimming</b> .....	29
■ <b>Installation of BU-TS W</b> .....	8	- <b>Assign a new receivers</b> .....	16	- <b>Blinds</b> .....	30
■ <b>BU-TS Installation-D</b> .....	9	- <b>Assigned receiver</b> .....	17	- <b>Detectors</b> .....	32
■ <b>Description of Control icons</b> ....	10	- <b>Detectors</b> .....	18	- <b>Quick control</b> .....	33
■ <b>Basic Steps</b> .....	11	- <b>Quick Control</b> .....	20	■ <b>What to do if</b> .....	34
		- <b>Display</b> .....	21	■ <b>Installation Form</b> .....	36
		- <b>Other</b> .....	21		

## Before you start

The instruction manual is intended for installation and use of the equipment. Instructions are always included in the product packaging. Installation and connection can only be made by personnel with appropriate qualifications, in compliance with all applicable laws, who are perfectly familiar with these instructions and functions. Trouble-free function is also dependent on transportation, storage and handling. In case of any signs of damage, deformation, malfunction or missing parts, do not install this product and return it to the seller. Product and its parts must be at the end of its lifetime handled as electronic waste. Before installation, make sure that all wires, connected parts or terminals are not live. During the installation and maintenance, it is necessary to follow safety regulations, standards, guidelines and special provisions for working with electrical equipment.

# Overview of wireless RF Control devices

## RF Control system

All actuators of the RF Control System can be controlled by wireless central unit and all transmitters of the system simultaneously.

## CENTRAL WIRELESS UNIT



**BU-TS-W**  
for surface mounting  
100 - 230V AC or  
adapter (external)  
12 V DC



**BU-TS-B**  
for mounting  
in the installation  
box  
100 - 230V AC

## CONTROLLER



**BU Pilot with LCD**  
remote controller,  
colours: white,  
anthracite

## TRANSMITTERS



**BU keychain**  
4-channel remote  
controller - key pendant



**BU-WS2 /G**  
2-channel wireless  
switch in the design  
LOGUS<sup>®</sup>



**BU-WS4/G**  
4-channel Wireless  
switch in the design  
LOGUS<sup>®</sup>



**BU-UT2**  
universal transmitter module  
under the switch or button  
wall box installation



**BU-UT4**  
universal transmitter module  
under the switch or button  
wall box installation

## BLIND ACTUATORS



**BU-SHUV**  
blind actuator  
2 x 8A switching  
relay protection  
230V AC

## TEMPERATURE ACTUATOR



**BU-TCU**  
wireless switching actuator  
with temperature sensor  
in design to installation box,  
230V AC

# Overview of wireless RF Control devices

## SWITCHING ACTUATORS



**BU-SU**  
single channel  
single function  
switching actuator  
1 x switching  
contact 16 A  
230V AC



**BU-SU Multi**  
single channel  
multifunction  
switching actuator  
1 x switching  
contact 16A  
230V AC

## DIMMING ACTUATORS

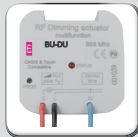

**BU-DU**  
single function  
dimming actuator  
1 light scene,  
function OFF, 230V AC

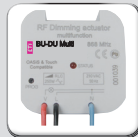

**BU-DU Multi**  
multifunction dimming actuator  
7 functions,  
AC 230V / 250V



**BU-DEU**  
multifunction dimming  
actuator  
7 functions, 230 V AC / 250VA  
Dimmed load: R, L, C, LED, ESL

## ANALOGUE ACTUATOR



**BU-DAU**  
actuator with analog  
output 0 (1) - 10 V  
1 x switch contact 16 A  
7 functions, 230V AC



**Dimmable ballast**  
for dimming of fluorescent  
lamps  
supplied on request  
with the product BU-DAU



**Thermo-control**  
of heating valves  
supplied on request  
with the product BU-DAU

## DETECTORS



**JA-80P**  
**JA-81M**  
**JA-82M**

# Characteristics of BU-TS

**Control Unit of the wireless system RF Control - BU-TS provides intelligent control of the BU units.**

**It can be used for:**

- Central control of all units from one place
- Complete overview (visualization) of the current status of units (appliances / equipment)

**Features:**

- sends command to temperature, switching, dimming and shutter actuators
- accepts commands from the transmitters, actuators, temperature sensors and detectors
- processing programs for heating and regulation

**Design:**

- BU-TSD fits in the round installation box with a supply voltage of 100 - 230 V AC
- BU-TSW for surface mounting with power supply from the back side: 100 - 230 V AC or from the side (via jack): 12 V DC
- 3.5 inch color touch screen - no mechanical buttons
- BU-TS frames in the base plastic (white, black) or luxurious design Logus<sup>90</sup> (glass, metal)
- Color of the interframes - white, ivory, ice, mother of pearl, aluminum, silver
- Colors of the boxes (only for BU-TSW) - white, ivory, dark gray, light gray
  
- Backup time in case of power failure is 48 hours
- 40 actuators and 30 OASIS detectors can be assigned to each BU-TS unit
- BU-TS can be combined with units of RF Control marked as Oasis & Touch Compatible

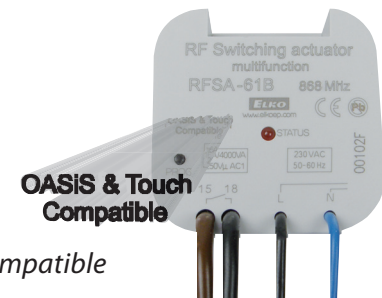

# Technical specifications

Technical parameters	BU-TSD	BU-TSW
<b>Display</b>		
Type:	color TFT LCD	
Resolution:	320 x 240 pixels / 262,144 colors	
Aspect ratio:	3 : 4	
Visible area:	52.5 x 70 mm	
Backlight:	active (white LED)	
Touch screen:	resistive 4-wire	
Display:	3.5"	
Control:	Touch sensitive	
<b>Power supply</b>		
Voltage / specific current:	100 - 230 V AC	from the back side 100 - 230 V AC from the side 12 DC *
Power consumption:	max. 5 W	
Power supply connector:	A1 - A2	
<b>Control</b>		
Range up to:	100 m	
Minimal range BU-TS – actuator:	1 m	
Frequency:	868 MHz	

Technical parameters	BU-TSD	BU-TSW
<b>Connection</b>		
	push-in	screwless terminal push-in or jack ø 2.1 mm
Max. cross section of wires:	max. 2.5 mm <sup>2</sup> / 1.5 mm <sup>2</sup> with socket	
<b>Operating conditions</b>		
Operating temperature:	0 ... +50°C	
Storage temperature:	- 20 ... +70°C	
Protection:	IP 20	
Overvoltage category:	III.	
Pollution degree:	2	
Operating position:	arbitrary	
Installation:	installatin a box	wall box installation
Dimensions:	94 x 94 x 12 mm	94 x 94 x 24 mm
Weight **::	127 g	175 g
Standards:	EN 60730-1	
* adapter is included for BU-TSW		

\*\* weight with plastic frame



## POWER SUPPLY OVER TERMINALS

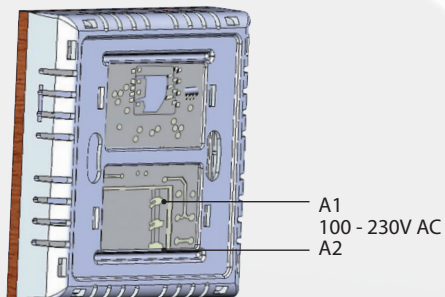

## FITTING ON THE SURFACE

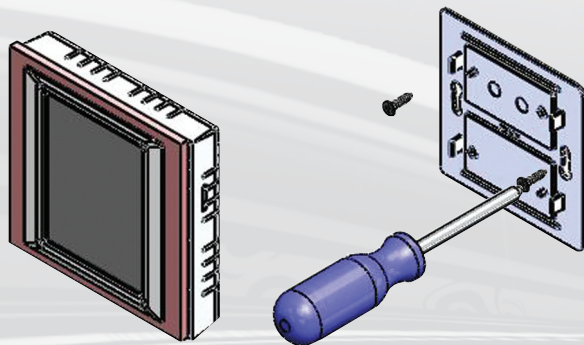

## POWER SUPPLY OVER ADAPTER

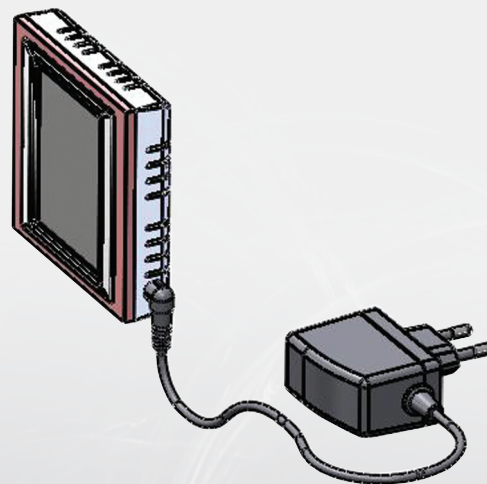

■ *adapter included with BU-TSW*



## POWER SUPPLY OVER TERMINALS

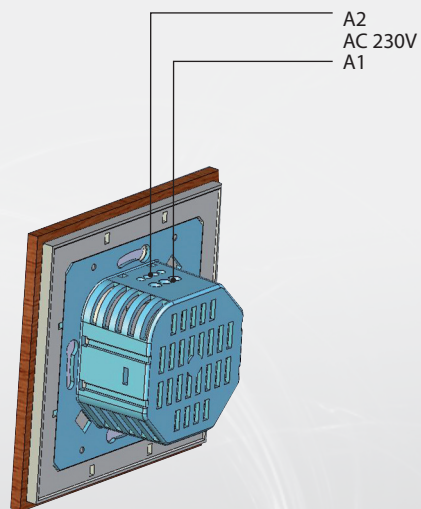



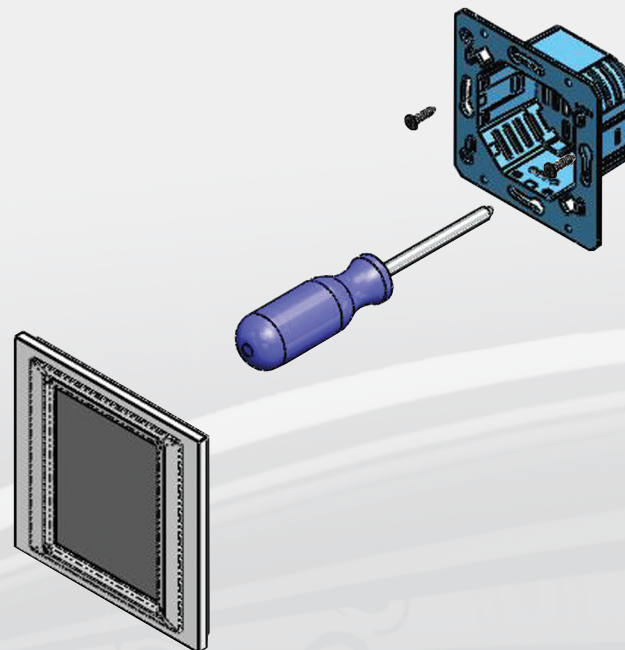

## FITTING TO THE INSTALLATION BOX











# Description of Control Icons







## Basic

-  BU-TS version Information and number of assigned units
-  settings
-  back to the home screen
-  step back







## Setup Menu

-  scroll up
-  scroll down
-  confirm
-  yes/selected
-  no/not selected
-  add
-  edit/remove
-  name/address of the actor(s)
-  delete

## Main menu

-  Temperature regulation
-  Switching
-  Dimming
-  Blinds
-  Detectors
-  Quick kontrol







## Keyboard

-  dot
-  letters
-  small/capital letters
-  space
-  switch - the letters / numbers
-  confirm
-  erase previous





## Heating

-  temperature

## Switching

-  switch ON
-  switch OFF
-  impuls
-  button
-  time function  
- delayed switch on  
- delayed switch off
-  regulation

## Dimming

-  switch ON
-  switch OFF
-  dimming
-  light inclination
-  light declination
-  confirm

## Blinds





-  rise blinds
-  lower blinds

# Basic Steps for Successful Programming

## 1st Step – Placing of the BU-TS and BU units

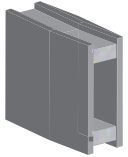
Keep in mind that the radio signal range of RF installation depends ON building construction, materials and placing of all units.

Transmission of radio-frequency signals through various materials.

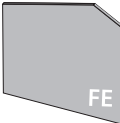
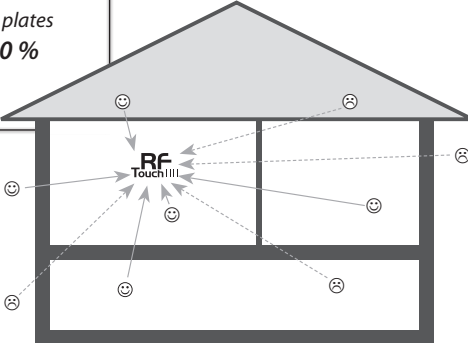
	Wooden structures with plasterboard plates <b>80-95 %</b>		standard glass <b>80-90 %</b>
	brick wall <b>60-90 %</b>		reinforced concrete <b>20-60 %</b>
	metal plates <b>0-10 %</b>		

## 2nd Step - Fill Installation Form

- device name that you want to manage (to create a menu)
  - the names of units (for the correct classification of the group, for example: BU-SU Multi)- addresses of units (to identify the actuator, for example: 577515)
- Installation form can be found at the end of this manual.

**Name**  
E.g. BU-SU Multi

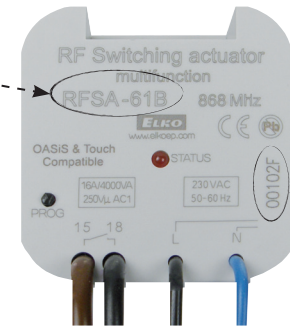

**Address**  
E.g. 577515

## 3rd Step - Set menus (create names)

Create a list of names of the controlled device in the Settings / Menu (create name).

## 4rd Step – Programming

Programming of the RF units with BU-TS is carried out in the Settings / Programming menu.

E  
N

## Initial setup

When the BU-TS is switched on for the first time, you will be automatically redirected to the display calibration screen. Touch screen can be controlled by the light touch (of about 0.5-1s) in the desired location. On the screen (Fig. 1) then appears cross in each corner of the screen, which need to be pressed twice. This will calibrate the device. The display then shows the icon  and then touch icon signaling scanning of the actuators.

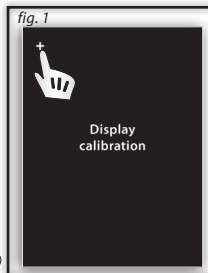

## Content of the main screen

- date
- time (touch in the upper right corner of the display will switch between analog - digital clocks (Figure 2 - Figure 3))
- display at the bottom of the screen is customizable, eg: heating mode, a often used device ... Touch the clock area to enter the Main menu. If you want to get to the main menu from sleep mode, you need to touch the screen anywhere.

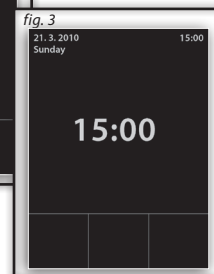

## Main Menu / Settings

The settings menu can be opened by touch in the upper right corner screen on the symbol  and insertion of password (it's setting from production - 1111) (fig. 4-6), which you can change everywhen.

## Language

Selection of required Language - Figure 6. Save setting by pressing **OK**.

## Date and time

Settings (Fig.7-8):

- Date and Time
- automatic transition between winter / summer time (for time Zone GTM +01:00)
- Format settings hours (12h / 24h mode)

To save Settings press **OK**.

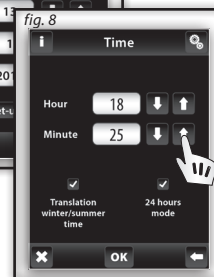
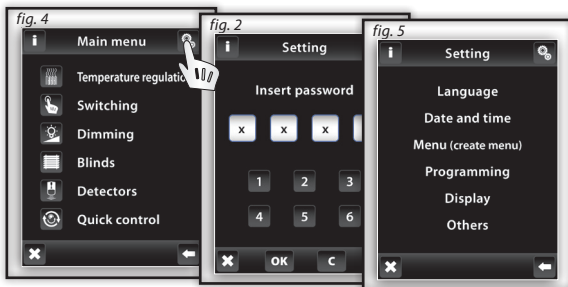

## Menu (create name)



**Menu (create name)** is used to add, edit or remove the names of the controlled device. In this menu (Figure 1) you need to first create your own device names for the sections you want to control.

Creating names is important for successful programming of the BU-TS. For each actuator, which is involved in the installation you have to create unique name.

The content of this menu is not set at the factory.

## Menu (create name) / Add



Press the **+** Add icon (Fig. 2) to show a selection of sections (Fig. 3):

- Temperature regulation
- Dimming
- Blinds
- Switching
- Control
- Speed
- Detectors

Choose the section where you want to add the device name and type your own text (max. 20 characters).

Example 1: If you want to control the blinds - Place the name to the section of the blinds (Fig.3-5).

Example 2: If you want to control a group of blinds together, first create all the blinds names in the blinds section and then create new name for group control in Quick control section.

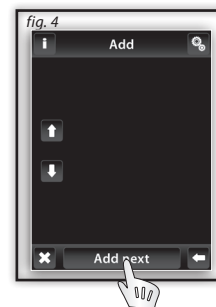

## Menu (create name) / Edit

**Edit** button is used to change or modify the name in the created menu.



Press the **Edit** icon  (Fig.1), a menu appears, select the section in which you want to edit created name (Fig. 2). Mark selected name by touching it (Fig. 3) and then edit with displayed keyboard.

Press **OK** to confirm (Fig. 4). The modified name is stored.



## Menu (create name) / Remove

**Remove** button can delete unit name.

Press the **Remove** icon  (Fig. 5) following menu appears, select the section from which you want to remove the name (Fig. 6). Pick the device you want to delete by touching it.(Fig. 7) . Press  to confirm the selection (Fig. 8). Selected name will be deleted from menu.







## Programming



**Programming** is used to assign or remove the actuators / detectors to menu you created.

The **Programming Menu** can be entered by entering a password (default - 1111).

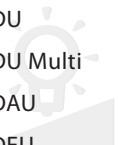
Actuators are divided into sections for which they are intended. According to the actuator's type you have to select appropriate section - see table (eg programming actuator BU-TCU - find it in the Temperature regulation section).

RF Control actuators divisions				
Temperature regulation	Switching	Dimming	Blinds	Detectors
BU-TCU/G 	BU-SU BU-DAU 	BU-DU BU-DU Multi BU-DAU BU-DEU 	BU-SHUV 	JA-81M / 82M JA-80P 

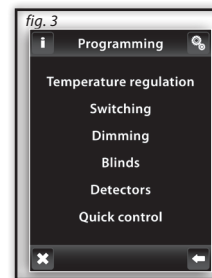

x internal sensor  
 xx external sensor  
 \* BU-SU Multi



## Programming / Assign new



It is used to assign a name to the actuator in the menu. In the required section (heating, dimming ...) select Assign new (Fig. 1). A list of selected sections actuators will be shown. (Fig. 2). Select the name of the actuator which you want to associate with the BU-TS. Enter the address of actuator you want to assign (Figure 3) as indicated on the actuator. Confirm with **OK**. From the menu you created, select the name to which the actuator will be assigned (Fig. 4).

- Only one name can be assigned for each actuator.

- When programming, actuator must be connected with the installation.

**Communication test** (Fig. 6) is used to detect and display the current status of the RF signal between the BU-TS and programmed actuator.

- Press **Start** (Fig. 7) to initiate the test, the current status of the signal is displayed in percentage.

- Press **Return** to Programming to get back to **main menu** of programming.

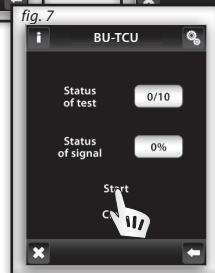
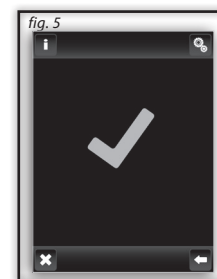
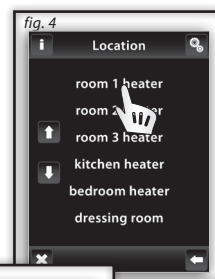
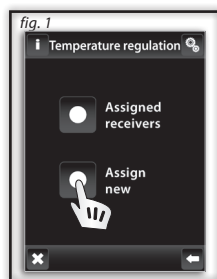

## Programming / Associated Receivers

It serves to control or remove the actuator from the name of the menu you created.

In the selected section (Figure 1 - Temperature regulation, dimming ...) select **Assigned receivers** (Fig. 2) a list of names specified in this section will be shown (Fig. 3). Touching on the name you will assign it to the actuator (Fig. 4).

By pressing  arrows you can check the name and address assigned to the actuator (Fig. 4, 5).

By touching the name or address of the actuator, you can Remove the actuator (Image 7), Change the address (Image 8), or perform a Communications test (Image 9) and Pair with ....switching actuators, or internal relays (Image 10).

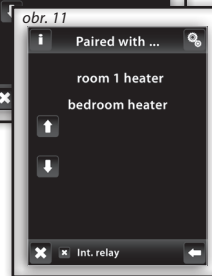
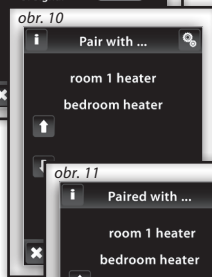
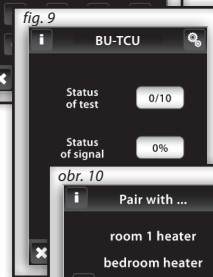
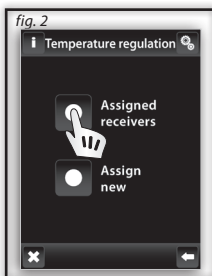

E  
N



Note: Two state JA-81M and JA-82M can be used in two ways:

- information about the status (open / close) - eg window is open (without pairing with a switching actuator)
- pairing with the multifunction switching actuator, which responds to the detector status (open / close)  
- eg light is switched on when you open the door.

Single state detectors (JA-80P) must always be paired with multi-function actuator.

## Programming / Detectors / Pair with ...

Paired detector can be paired with the multifunction switching actuator from switching menu, (eg, motion detector with entrance light, Fig. 2-3).

One detector can be paired with up to 30 multifunction switching actuators.

If the detector is paired with a switching actuator function of **delayed off** feature is automatically activated. When detector switch on, actuator switches connected device for preset time (2s - 60min). Time delay can be set in the main **Menu / Control** of the paired actuators (see page 26).

The above method can be used to assign additional detectors. The BU-TS can be programmed with up to 30 detectors.

Note: The minimum distance between the detector and BU-TS is 1.5 meters.

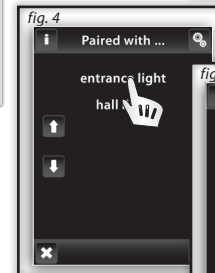
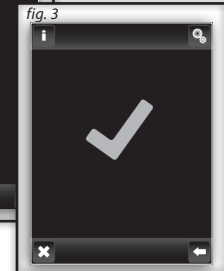
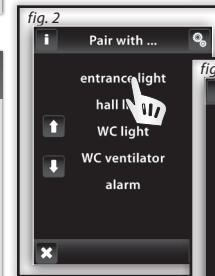
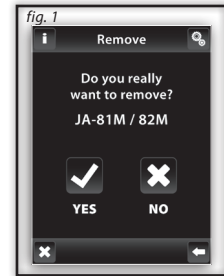

## Programming / Quick Control



**Quick control** is used for creating a group command, where one-touch control multiple actuators.

For each name of group command you can assign a combination of up to 20 different actors.

Note: Quick control can be set only when all actuators are programmed in different sections of switching, dimming and blind control.

In the **Quick Menu** control (Fig. 1) choose name from list for the group command (Fig. 2).

Select **Assign new** (Fig. 3) it will show group of units (switching, dimming and blind control). Select the section you want to assign for desired command name (Fig. 4). You can create a menu for your device names created in the desired section.

Select the name (Fig. 5) and further define the function (Fig. 6).

The unit will returns to display groups of units (switching, dimming and blind - fig. 7), where you can continue with programming. When you select assigned receiver (Fig. 8) you can go to the menu to remove (Fig. 10) or change the device name



Note: The Remove function removes a group command name from the BU-TS unit memory. The actuators will remain in the memory.

## Setup / Display (fig. 1-2)

- **Background:** select the type of screen background color (black, blue, green, purple).
- **Screensaver:** the desired brightness (25%, 50%, 75%, 100%) will be activated after preset time since the last touch (15s, 30s, 1min, 3min).
- **Sleep mode:** set the time after which BU-TS screen unit goes to sleep - the screen goes dark (0min, 10min, 15min, 20min).
- **Calibrating the display:** cross appear in every corner of the screen, which need to be pressed twice. Calibration will be performed. Display calibration can also be started by resetting the unit or disconnecting the supply voltage from the unit; after connecting again, the BU-TS logo will appear on the display - hold the logo for more than 3s to activate calibration – touch logo longer than 3 seconds and calibration will be activated. After calibration, the display shows Home screen.

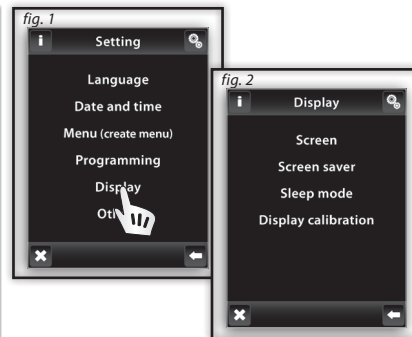

## Setup / Others (fig. 3-4)

- **Change Password:** Changes the password for Setup menu. Enter password - Figure 5 (default password 1111) will start the the screen to select a new password - where you type and confirm new password. Touch **OK** to save the new password (Fig. 6).
- **Reset the device:** To reset the password use 1234 (Fig. 7). This password cannot be changed. Password, and confirmation YES (Fig. 8) to return the BU-TS unit to the factory settings. BU-TS restarts without entering the password confirmation OK. (Settings remain unchanged)

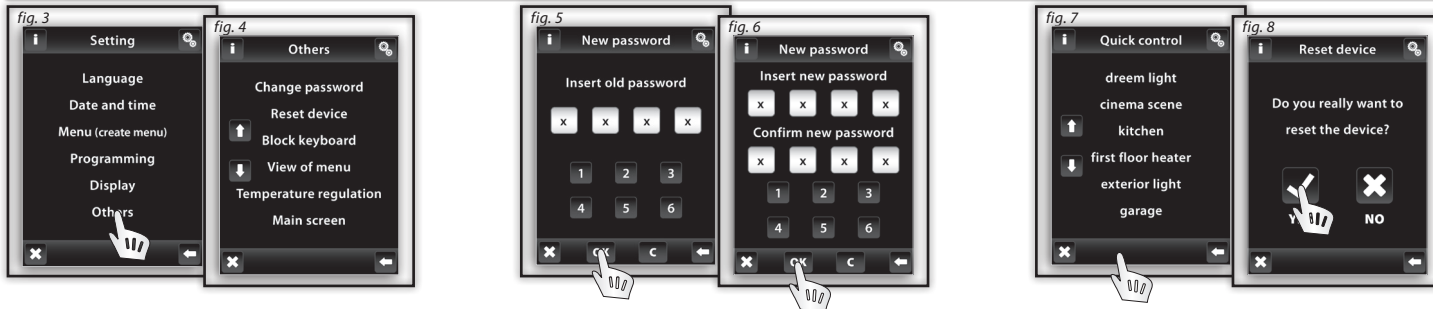

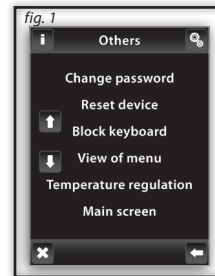
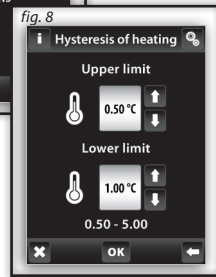
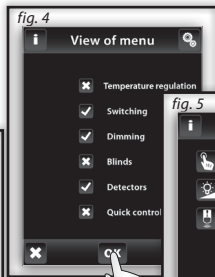
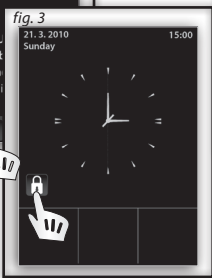





## Control / Temperature regulation

**Temperature regulation Menu (Fig.1)** is designed for setting controls over heating equipment. Touch the heating you enter the menu of additional circuits (image 2).

**Standard mode** **Economic mode** **Party mode** **Anti-freezing mode**

These modes offer a preset temperature, which you can adjust as you need for individual heated rooms (circuits). By activation of Standard, Economic, Party or Anti-freezing mode, the Temperature Regulation adjusts the set temperature. By touching one of the icons, you activate the chosen mode for the selected room (heating circuit).

**The Anti-freeze mode** is designed to maintain the minimum required temperature in a range of 5 - 15°C.

**Heating program** can be used to set the heating regime for the whole week.

**Holiday mode** is used for temporary interruption of the heating program or other heating mode.

Note: Setting Units °C / °F and hysteresis for heating is done in the Settings / Other / Heating

## Temperature regulation / Changing heating modes to Economy, Normal and Party modes

To edit the mode, first select the settings button (image 3), then the relevant mode to modify (Fig. 4) - Standard, Economic, Party or Anti-freezing mode. The current temperature and the set temperature for Switching on the selected mode is displayed at the icon. Touch Settings icon (Fig. 5) for adjusting the temperature. Arrows / can set the desired temperature (longer pressed arrow will accelerate changing of numbers) Touch to save the set temperature (Fig. 6).

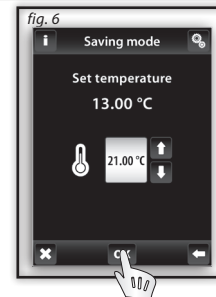



## Temperature regulation / holiday mode





**Holiday mode** is used for temporary interruption of the heating program.

Touch **holiday mode** (Fig. 1) to open **Switch ON** screen where you set the date, month and year when your holiday mode should start. Confirm with **OK** (Fig. 2). **Switch Off** screen appears where you set the day month and year for the end of holiday mode. Confirm with **OK**.

If you touch Overview icon(Fig. 3) you can check list of holiday programs.

Note: Up to 5 Holiday modes can be assigned up to 5 time intervals. Times of programs may not overlap. During the holiday Economy mode is active.

Individual deletion of **Holiday Mode** is selected by touching bar belonging to the program(Fig. 4), then touch the bin icon  and program will be erased. If you do not mark any bar you can touch the bin icon  to remove all **holiday** arrangements.

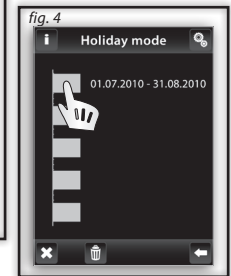
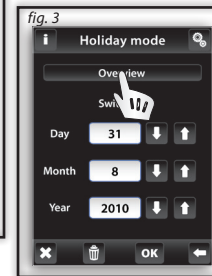
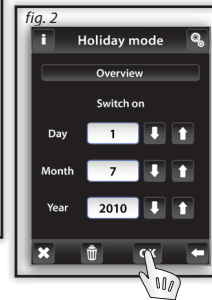





## Main menu / Switching



**Switching menu** is for all the devices you want to switch. Touch **Switching** (Fig. 1) displays the names of your choice created in menu. Red / Green LED indicates contact status:  green -ON,  red switched - off. Touch the desired name (Fig. 2) to show basic functions:  **switch on**  **switch off**.

## Switching / Function

Press the **Next functions** button (Fig. 3) will show a selection of switching functions (Fig. 4). Other functions can be used only in combination with multifunction switch actuators - BU-SU Multi

- Impulse** –first touch  switch on, second one to switch off.
- Button** – It is on as long as long you are holding button .
- Delayed switch on** - touch  will begin to count preset time, after which the actuator switch on.
- Delayed switch off** -touch  will start to count preset time after which the actuator will switch off.

In the section **Time settings** all times for **Delay on** and **Delay off** can be set.

Time delay can be set in the range from 2 to 60 minutes. Touch-hour time interval (or minutes) to  indicate the information you want then change it (Fig. 5) with Arrows  / .

Note: longer press of arrows will accelerate shifting of figures. Confirm time setting by pressing **OK**.



## Main menu / Switch on / BU-DAU



Upon selecting the Switching on menu to which the BU-DAU actuator is assigned, the basic function are displayed:

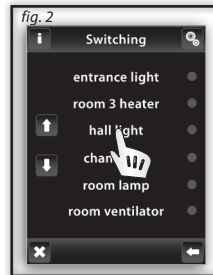

- Switch on
- Switch off.

Press shortly the arrows / at the Regulation icon to set the desired value (Fig. 3). Touch to perform the command.





## Switching / Weekly Program

**Weekly program** provides weekly settings for the automatic mode switching.



Touch **Weekly program** icon (Fig. 1), setup menu will appear. Touch-hour time interval (or minutes) to mark information you want to change. Arrows  /  will set the time of **switch On** and **switch Off**.

Note: longer press of arrow is accelerate shift of figures.

Touch the Sun-Sat icon will activate the program on a given day of the week (Fig. 2).  - active for the day,  - disabled for the day. To confirm of selected programs touch . If you want to configure other Switching program continue programming.

Note: For one day you can create up to 5 switching programs. Programs must not overlap. Setting of program until midnight and over midnight - see page 37.

**Daily / Weekly Overview** shows the daily / weekly overview of **switching programs**.

To delete a program in the **Daily overview** (Fig. 3) indicate bar you want to delete (Fig. 4) at then press the bin icon  to delete it. If you not select any of programmed bars and press bin icon , you will remove all schedules in the day.

**Weekly overview** (Figure 5-6) touch the bin icon  to clear all programs.

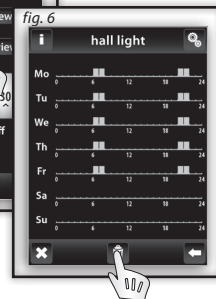
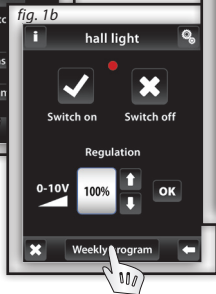

## Main menu / Dimming



**Dimming Menu** is for all the lights where you want to control the brightness (load R L, C - 250V). **Touch-Dimming** (Fig. 1) to display a selection of names you created in menu (Fig. 2).

Red / Green LED indicates contact status:  **green- On**  **red -Off**.

## Dimming/Functions



Touch the desired name to displays basic functions:  **switch on**  **switch off**. A short touch on the arrows / beside icon **Dimming** will set the desired brightness (Fig. 3). Touch **OK** to confirm. In the case displayed icon - level has been set by other controller (Fig. 4).

**Further functions** (Fig. 5) can be used only in combination with multifunctional dimming actuators - BU-DU Multi and analog actuator BU-DAU.

- Smooth start** - touch will start smooth start-up for preset time.
- Smooth stop** - touch will start smooth run down for preset time.

In the **Setting** you can set time for **smooth start** and **smooth stop**. Time can be set from **2s to 30 minutes**. Touch the time interval hours (or minutes) to indicate the information you want to change (Fig. 6). Arrows / will set time. Confirm setting by pressing **OK**.

Note: longer press of arrows will accelerate shifting of figures.

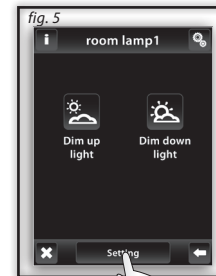
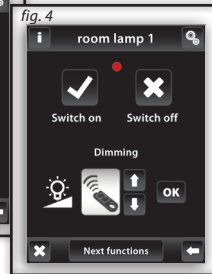
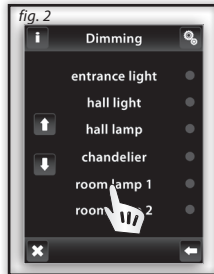



## Main Menu / Blinds



*Blinds Menu is designed to control all shutters, blinds, awnings, gates and garage doors that have a built-end switch. Touch the **Louvre**  (Fig. 1) to display selection of names you created in menu (Fig. 2). Red / Green LED indicates device status:  green- closed blinds  red – open blinds.*

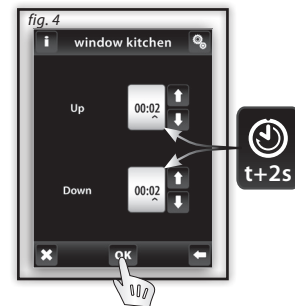

## Blinds / Weekly program



**Weekly program** can adjust automatic weekly mode.

Touch **Weekly program** icon (Fig. 1), setup menu will appear. Touch-hour time interval (or minutes) to mark information you want to change. Arrows / will set the time of switch On and switch Off .

Note: longer press of arrow is accelerate shift of figures.

Touch the Sun-Sat icon will activate the program on a given day of the week (Fig. 2). - active for the day, - disabled for the day.

Confirmation of the selected program - . If you want to set additional blinds program to continue with programming.

Note: For one day you can create up to 5 blinds programs. Programs must not overlap (Fig. 5). Setting of program until midnight and over midnight - see page 37.

**Daily / Weekly Overview** shows the daily / weekly overview of switching programs.

To delete a program in the Daily overview (Fig. 3) indicate bar you want to delete (Fig. 4) at then press the bin icon to delete it. If you not select any of programed bars and press bin icon, you will remove all schedules in the day.

Weekly overview (Figure 5-6) touch the bin icon to clear all programs.

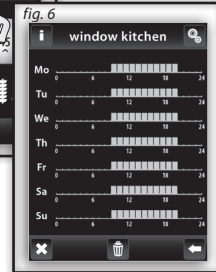
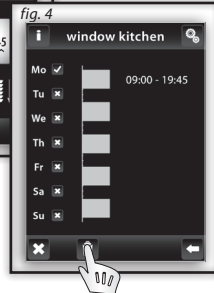

Note: Setting the Inversion function: touch / in the Weekly programme to set the initial movement of the roll-up blinds (Fig. 7).



## Main Menu / Detectors

The menu **Detectors** is used for the visualisation and switching of devices using detectors. By touching the option **Detectors** (Fig. 1) you will display the list of names on the detector menu that you have created (Fig. 2).

## Double State Detectors

Double state detectors (JA-81M - doors; JA-82M - windows) feature state visualisation:

- Green – Off state
- Red - On state.

JA-81M and JA-82M detectors may be used in two ways:

- Information regarding the state (On/Off) - e.g. open window (without pairing with the switching actuator)
- Pairing with the multifunctional switching actuator (On/ Off) - e.g. light switched on when door opened. By touching the name of the detector you will display the name of the switching devices with which the detector is paired. By pressing the name of the switching device you will display the selection (Fig. 4):

**On state (neutral):**

**Off state (alarm):**

- Switch off - switched off without delay.
- Delayed run out – switches off after the time period set in the switching settings.
- Switch on - switches on without delay.
- Delayed onset – switches on after the time period set in the switching settings.

Confirm by pressing **OK** (Fig. 4).

Note: The time delay is set for the paired actuator.

## Single State Detectors

Single state motion detectors JA-80P do not feature state visualization and they are designed for pairing with the multifunctional switching actuator. By touching the name of the detector you will display the name of the switching actuator with which the detector is paired. Note: The function of Delayed Switch Off is automatically allocated to the detector. The time delay is set for the paired actuator.

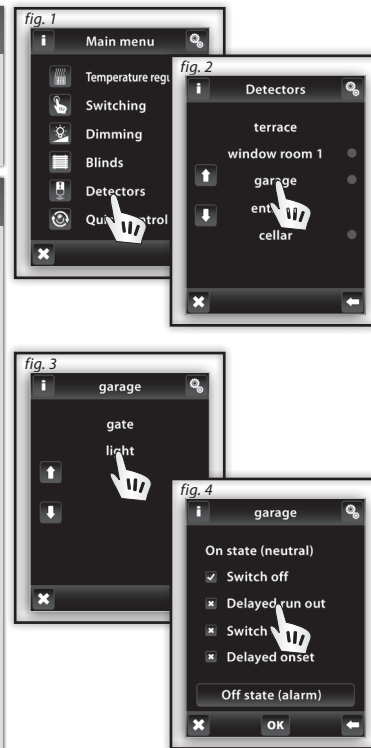

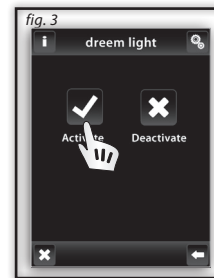

## BU-TS Unit Warnings

*Warning is displayed in case of incorrect or incomplete entry.*

<i>Warning</i>	<i>Procedure</i>
<i>Up to 40 rooms may be defined.</i>	<i>no more than 40 device names may be entered</i>
<i>Saving failed.</i>	<i>repeat entry</i>
<i>Delete failed.</i>	<i>repeat entry</i>
<i>No unit allocated.</i>	<i>allocate the requested actuator</i>
<i>Two time programmes overlap within a single day.</i>	<i>enter new settings</i>
<i>No time programme available within a single day.</i>	<i>no other programme can be entered</i>
<i>No day selected.</i>	<i>enter new settings</i>
<i>Switch on time may not exceed the switch off time.</i>	<i>enter new settings</i>
<i>Unit already allocated to the room. Select another room.</i>	<i>only one actuator can be allocated to one name of device (outside Quick Control)</i>
<i>This room has already been defined in the group.</i>	<i>enter a new name</i>
<i>The address has already been selected in the unit list. Choose another address.</i>	<i>enter correct information</i>
<i>The address information must be complete.</i>	<i>enter correct information</i>
<i>xxx displayed instead of temperature.</i>	<i>actuator not programmed, actuator/sensor defect, communication failure</i>
<i>Up to 40 units may be defined.</i>	<i>no more than 40 units may be entered</i>
<i>The switch on date must be different from the switch off date.</i>	<i>enter new settings</i>
<i>The switch on date must not exceed the switch off date.</i>	<i>enter new settings</i>
<i>All 5 programmes are engaged.</i>	<i>no other programme can be entered</i>

## BU-TS Unit Warnings

Warning	Procedure
No unit allocated to the room.	allocate actuator
This group has already been allocated.	enter new settings
Display incomplete - control impossible.	calibrate the device (disconnect the power supply, after reconnecting hold the logo BU-TS, finish the calibration by touching twice the cross signs that appear in each corner of the screen)
EPROM memory error!	contact the manufacturer
RTC circuit error!	contact the manufacturer
AT45 circuit error!	contact the manufacturer
Setting of program until midnight and over midnight - at the time of 00:00 there isn't any action on the actuator.	- setting of time over midnight : set the required "switch ON" time and set the required "switch OFF" time on 00:00, next day set the switch ON" time on 00:00 and set the required "switch OFF" time.  - setting of time until midnight: set the required "switch ON" time and set the required "switch OFF" time on 23:59
Have you lost the password?	please ask the manufacturer for information about further steps

### General Information

With consideration to the transmission of the RF signal ensure that BU components are suitably located in the building where the device is to be installed. The RF Control system must only be installed in indoor areas. The device has not been designed for outdoor use or use in moist environment, it must not be installed in metal distribution boxes and plastic distribution boxes with metal doors as this would prevent the transmission of the radio frequency signal. RF Control is not recommended for the control of devices providing for vital life functions or for the control of risk devices such as pumps, electrical heaters without heat regulators, lifts, pulleys etc. - radio frequency transmission could be hampered with an obstacle, interfered with, the transmitter battery may become depleted etc. thus disabling the remote control. Not suitable for use in industrial environment.  
Do not expose to extreme temperature changes. In case of extreme temperature changes allow approx. 2 hours prior to installation for the BU-TS to adjust to the temperature of the installation location. This will prevent condensation of moisture in the device and the occurrence of a potential short circuit.  
Keep flammable materials away from the device.

The graphic indication of the contact / device status (red/green LED) is only for information and may be influenced by the amount of processed information or the combination of more BU-TS and BU Pilot with LCD control units.

Safety functions in BU-TCU actuator: the actuator disconnect the output in case of an accidental communication failure exceeding 25 minutes.

# Installation Form

<i>Serial no.:</i>	<i>Description / Name of the controlled device</i>	<i>Actuator name</i>	<i>Actuator address</i>
1.			
2.			
3.			
4.			
5.			
6.			
7.			
8.			
9.			
10.			
11.			
12.			
13.			
14.			
15.			
16.			
17.			
18.			
19.			
20.			



# Installation Form

<i>Serial no.:</i>	<i>Description / Name of the controlled device</i>	<i>Actuator name</i>	<i>Actuator address</i>
21.			
22.			
23.			
24.			
25.			
26.			
27.			
28.			
29.			
30.			
31.			
32.			
33.			
34.			
35.			
36.			
37.			
38.			
39.			
40			



**ETI Elektroelement d.d.,**

Obrezija 5,

SI-1411 Izlake Slovenija

Tel.: +386 (0)3 56 57 570,

Fax: +386 (0)3 56 74 077

e-mail: [eti@eti.si](mailto:eti@eti.si)

Web: [www.eti.si](http://www.eti.si)

rev.0